

User manual

MANUEL D'UTILISATION
GEBRUIKSAANWIJZING
GEBRAUCHSANWEISUNG
MANUALE DI ISTRUZIONI
MANUAL DE INSTRUCCIONES
INSTRUKCJA OBSŁUGI
NÁVOD K OBSLUZE

Trigo T



Content

Content	1
Preface	2
1 Your product	3
1.1 Accessories	3
2 Before use	4
2.1 Intended use	4
2.2 General safety instructions	4
2.3 Transport	5
2.4 Folding - unfolding	7
2.5 (Dis)Assembling rear wheels	7
2.6 Storage	7
3 Using your wheelchair	8
3.1 Parking brakes	8
3.2 Push handles (stepless adjustments).....	8
3.3 Armrests – Side plates	9
3.4 Foldable backrest	9
3.5 Anti-tipping (optional)	9
3.6 Removing/mounting footrests.....	9
3.7 Comfort adjustments	10
3.8 Moving to/from wheelchair	11
3.9 Riding	11
4 Maintenance	12
4.1 Points of maintenance	12
4.2 Maintenance instructions.....	12
4.3 Troubleshooting.....	13
4.4 Expected lifespan	13
4.5 Reuse	13
4.6 End of use	13
5 Technical specifications	14

Preface

Congratulations! You are now owner of a Vermeiren wheelchair!

This wheelchair is made by qualified and committed personnel. It is designed and produced according to high quality standards, guarded by Vermeiren.

Please read this manual carefully; it will help you to get familiar with the operation, capabilities and limitations of your wheelchair. If you still have questions after reading this manual, do not hesitate to contact your specialist dealer. He/she will be glad to help you.

Important note

To ensure your safety, and to prolong the lifetime of your product, please take good care of it and have it checked and serviced on a regular basis.

This manual reflects the latest product developments. Vermeiren has the right to implement changes to this type of product without any obligation to adapt or replace similar products previously delivered.

Pictures are used to clarify the instructions in this manual. Details of the depicted product may deviate from your product.

Information available

On our website <http://www.vermeiren.com/> you will always find the most recent version of the information in this manual. Please consult this website regularly for possible updates.

Visually impaired people can download the electronic version of this manual and have it read out by means of a text-to-speech software application.



User manual

For user and specialist dealer



Installation instructions

For specialist dealer



Service manual for wheelchairs

For specialist dealer



EC declaration of conformity

1 Your product

This Trigo T wheelchair is an active, foldable wheelchair, with two removable footplates and a wide range of adjustment options. It is easy to operate by the occupant and can be used indoors as well as outdoors.

The Trigo T is available with the options as shown on our website, see also §5.

1. Backrest
2. Side plate (with optional armrest)
3. Seat
4. Frame
5. Footplate (2x)
6. Front wheel
7. Rear wheel
8. Push handle (optional)
9. Footrest
10. Brake
11. Identification plate



1.1 Accessories

The following accessories are available for Trigo T:

- Crutch holder
- Anti-tipping wheel
- Travel castors
- Backrest stabilisation bar
- Pelot – side support left/right
- Off road wheels 24"
- Gel cover push rim
- Spoke protection
- Anterior pelvic support

2 Before use

This manual is applicable to the wheelchair Trigo T, in all its configurations.

2.1 Intended use

- This wheelchair is suitable for indoor and outdoor use.
- This wheelchair is designed and produced solely to transport/transfer one (1) person with a maximum weight, according to the configuration of the technical specifications in § 5. It is not designed to transport goods or objects, nor for any other use as previously described.
- This wheelchair is meant to be operated by the user sitting in the wheelchair. If push handles are installed, it can be operated by an attendant as well.
- You should NOT use this wheelchair if you suffer from physical or mental impairments that may put you, or other people, in danger when riding the wheelchair. For this reason, consult your doctor first and make sure that your specialist dealer is informed about his advice.
- Only use accessories and spare parts approved by Vermeiren.
- Please read all technical details and limits of your wheelchair in § 5.
- The warranty of this product is based on normal use and maintenance as described in this manual. Damage to your product caused by improper use or lack of maintenance will cause the warranty to lapse.

2.2 General safety instructions

 CAUTION Risk of injuries and/or damage

Carefully read and follow the instructions in this manual.





Keep the following general warnings in mind during use:

- Do not use your wheelchair if you are under influence of alcohol, medicines or other substances that may influence your riding abilities.
- Be aware that some parts of your wheelchair may get very hot or cold due to ambient temperature, solar radiation or heating devices. Be careful when touching. Wear protective clothing if the weather is cold. When going outdoors, riding gloves can be used to improve the grip on the hand rims.
- Alterations or substitutions should not be made to the wheelchair securement points or to structural and frame parts or components without consulting the wheelchair manufacturer.

Be aware that your wheelchair may interfere with some types of anti-theft systems, depending on the settings used. This may cause the shop's alarm to go off.

In case a serious incident has occurred involving your product, notify Vermeiren or your specialist dealer as well as the competent authority in your country.

The symbols in following list are applicable to your wheelchair. Symbols can be found in the relevant ISO standard (ISO 7000, ISO 7001 and IEC 417).

	Maximum weight of the user in kg
	Indoor/outdoor use
	Maximum safe slope in ° (degrees)
	Type designation



Risk of entrapment

2.3 Transport

2.3.1 Transport by vehicle, as luggage

1. As user, transfer to a car seat, see §3.8.
2. Fold the wheelchair to its most compact size according to the instructions in § 2.4.
3. Store the wheelchair and its wheels in the luggage compartment or behind the passenger seat. If luggage and passenger compartments are NOT separated or enclosed, fasten the wheelchair frame securely to the vehicle. You can use the available safety belt in the vehicle. Never use the same safety belt for passenger and wheelchair.

2.3.2 Use of the wheelchair as seat in a motor vehicle (only for Trigo with fixed backrest)

 **WARNING** Risk of injuries



- For Trigo with foldable/angle adjustable backrest: Do NOT use your wheelchair as a seat in a vehicle, see the following symbol.
- The wheelchair has passed the crash test of ISO 7176-19: 2008 and, as such, has been designed and tested for use only as forward-facing seat in a motor vehicle. Ease of access to, and manoeuvrability in, motor vehicles can be significantly affected by wheelchair size and turning radius.
- The wheelchair's pelvic belt alone is not suited as an occupant restraint belt.
- Use the wheelchair's pelvic belt and the applicable three-points belt in the vehicle to prevent head and chest impacts with the vehicle.
- Do not use postural supports to restrain the user in the vehicle unless they are labelled as being in accordance with the requirements specified in ISO 7176-19:2008.
- Following involvement in any type of vehicle collision, have your wheelchair inspected by the specialist dealer or manufacturer's representative before reuse.

The wheelchair is tested using the four-point strap-tie system and a 3-point occupant-restraint system.

Whenever feasible, use the seat of the vehicle and store the wheelchair in the cargo area.

Steps to secure the wheelchair in a motor vehicle:

1. Check that the vehicle is equipped with a suitable wheelchair tie down and occupant-restraint system, conform ISO 10542.
2. Check that the components of the wheelchair tie down and occupant restraint system are not frayed, contaminated, damaged or broken.
3. If equipped with an adjustable seat and/or back tilt, make sure that the wheelchair user is sitting as upright as possible. If the user's condition prevents this, a risk assessment should be done to evaluate the user's safety during transit.
4. Remove all mounted accessories such as trays and respiratory equipment, and secure them in a safe place.
5. Position the wheelchair facing forward in the travelling direction, centrally between the tie-down rails mounted in the floor of the vehicle.
6. Mount the front securement straps according to the instructions of the strap-system manufacturer at the indicated place (figure 1). This place is marked on the wheelchair with a symbol (figure 1).
7. Roll back the wheelchair until the front straps are tight.
8. Apply the wheelchair brake.
9. Mount the back securement straps according to the instructions of the strap-system manufacturer at the indicated place (figure 1). This place is marked on the wheelchair with a symbol (figure 2).



Figure 1



Figure 2

Steps to secure the wheelchair user:

1. Remove both armrests (if possible).
2. If present, attach the wheelchair's pelvic belt.
3. Attach the occupant restraint belts according to the instructions of the strap-system manufacturer.
4. Wear the pelvic belt low across the front of the pelvis, so that the angle of the pelvic belt is within the preferred zone of 30° to 75° to the horizontal, similar to that shown in the figure.
5. A steeper (greater) angle within the preferred zone is desirable.
6. Adjust the belt tightly according to the instructions of the strap-system manufacturer, consistent with the user's comfort.
7. Ensure that the restraint belt connects in a straight line to the anchor point in the vehicle and that no bends in the belt are visible, for instance at the axle of the rear wheel.
8. Install the armrests, if desired. make sure that belts are not twisted or held away from the body by wheelchair components such as armrests or wheels.
9. Position the seatbelt buckle so that the release button will not be contacted by wheelchair components during a crash.
10. Make sure that the shoulder-belt restraints fit over the shoulders, see figure 4.

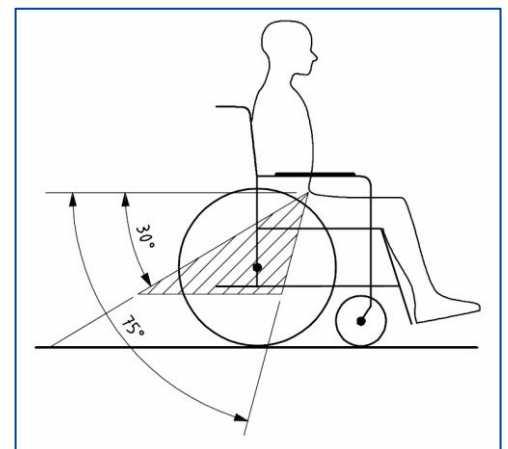

Belt restraints must not be held away from the body by wheelchair components such as armrests or wheels.

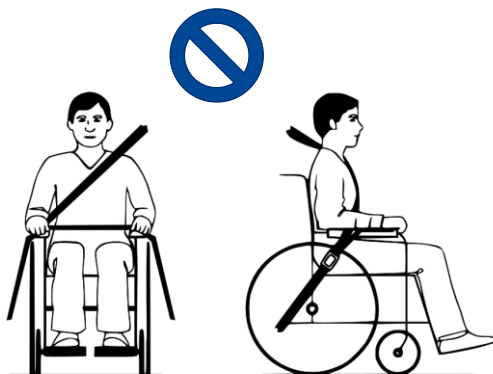

Figure 3 Improper belt-restraint fit

Belt restraints make full contact with shoulder, chest and pelvis.

Pelvic belt low on the pelvis near the thigh-abdominal junction

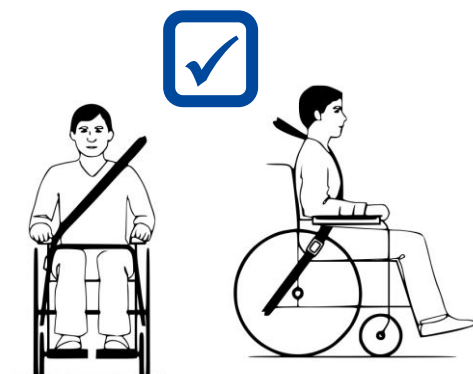
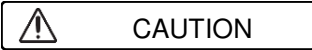

Figure 4 Proper belt-restraint fit

2.4 Folding - unfolding



Risk of injuries and/or damage

- Make sure that your fingers don't get trapped at the pivot point of the handles and frame cross.
- Always keep the swing range of the footplate in mind to prevent bystanders from being injured or objects from being damaged.

To fold the wheelchair:

4. Pull the seat cushion and remove it.
5. Remove the footrests, see §3.6.
6. Grab the front and back of the seat (15) in the middle, and pull to close.
7. Push seat frame tubes (5) together.
8. Remove the rear wheels If necessary, see §2.5.



To unfold the wheelchair:

1. Pull the seat frame tubes (5) outwards, and push the seat frame down at the left and right side until the seat is flat and the frame is locked into place.
2. If removed, assemble the rear wheels, see §2.5.
3. Place the seat cushion (4) on the Velcro straps of the seat. Make sure that the straps of the seat cushion lie transverse over the straps of the seat.
4. Mount the footrests, see §3.6.

2.5 (Dis)Assembling rear wheels

To remove the rear wheels

1. Press and hold button (43) while sliding the wheel axle out of the hole of the frame.
2. Repeat this for the other wheel and place the wheelchair gently on the rear frame tubes.

To install the rear wheels

1. Take one of the rear wheels and lift the wheelchair on one side.
2. Press and hold button (43) while sliding the wheel into the axle bushy.
3. Release the button to lock the wheel. Make sure it clicks into place.
4. Repeat this for the other wheel.
5. Ensure that both wheels are firmly secured.



2.6 Storage

- i** Make sure that your wheelchair is stored in a dry environment to prevent mould from growing and the upholstery from being damaged, see also chapter 5.

3 Using your wheelchair



CAUTION

Risk of injuries and/or damage

Make sure that your hands, clothes, belts, buckles or jewellery don't get caught by wheels or other moving parts, during use or adjustment.

3.1 Parking brakes



CAUTION

Risk of injuries and/or damage

- Never release both brakes simultaneously.
- Brakes may only be adjusted by your specialist dealer.
- Do not use the parking brakes to slow the wheelchair down during movements.

Push-pull brakes

- i** The push/pull parking brake can be mounted in two ways (directions), to be decided upon ordering the wheelchair. Depending on the chosen direction, the brake needs to be pushed or pulled for operation.

Releasing brakes (A):

1. With one hand, hold one of the hand rims.
2. Push or pull brake lever (10) of the OTHER wheel.
3. Repeat this for the second wheel and parking brake.



Applying brakes (B):

1. With one hand, hold one of the hand rims.
2. Pull or push brake lever (10) of the OTHER wheel until you feel a distinctive lock.
3. Repeat this for the second wheel and parking brake.



Sport brakes

The sport brakes are located under the seat.

Releasing brakes :

1. With one hand, hold one of the hand rims.
2. Pull the handle of the OTHER wheel BACKWARDS.
3. Repeat this for the second wheel and parking brake.

Applying brakes :

1. With one hand, hold on of the hand rims.
2. Push the brake handle of the OTHER wheel forward until you feel a distinctive lock.
3. Repeat this for the second wheel and parking brake.



3.2 Push handles (stepless adjustments)

Depending on the chosen configurations, your wheelchair can be delivered without push handles, or it can be provided with normal handles, or foldable handles.

3.3 Armrests – Side plates

Depending on the chosen configurations, your wheelchair can be provided with a range of different armrests:

- Fixed side sideplates without armrests
- Fixed sideplates with armrests
- Foldable tubular armrests
- Removable sideplates

3.4 Foldable backrest

To fold the backrest onto the seat

1. Gently pull the back strap (20). The safety pins of the folding mechanism (21) are released.
2. Push the backrest down onto the seat.

To pull the backrest up

1. Pull the backrest up until it clicks into position.
2. Make sure that both safety pins are locked in the holes of the folding mechanism (21).
3. Check by moving the backrest.



3.5 Anti-tipping (optional)

The anti-tipping device prevents your wheelchair from tipping over backwards. When the device is not needed, it can be swung to the side by pulling the vertical bar (16) down and turning it towards the front of the chair, until it clicks into place.

To adjust the height of the anti-tipping device according to the position and size of the rear wheels:

1. Loosen the star knob (17) until the inner tube of the anti-tipping can be moved in the support.
2. Slide the anti-tipping up/down until the desired position.
3. Tighten the star knob (17).

The anti-tipping should be approximately 15-20mm above the ground.



3.6 Removing/mounting footrests

To remove the footrests

1. Pull the lever (22) on the footrest to the side.
2. Swing the footrest to the side of the wheelchair.
3. Take the footrest out of the footrest support (23).
4. Repeat for the second footrest.

To mount the footrests

1. Place the footrest in the footrest support (23), holding the footrest on the side of the wheelchair.
2. Turn the footrest to the front until it clicks into place.
3. Repeat for the second footrest.

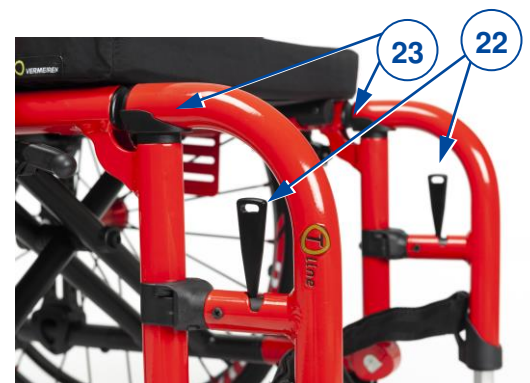

3.7 Comfort adjustments



CAUTION

Risk of injuries and/or damage

- The following comfort adjustments can be done by the attendant or caretaker. All other adjustments are done by your specialist dealer (see installation instruction).
- Always keep the swing range of the footrest in mind to prevent bystanders from being injured or objects from being damaged.
- Make sure that your fingers, clothes, buckles won't get entrapped during adjustment.

3.7.1 Backrest width and support

The backrest of the wheelchair has a suspension system with three adjustable straps, to adjust the width and flexibility of the backrest.

1. Pull the backrest cushion from the Velcro straps of the backrest.
2. Loosen the Velcro straps.
3. Pull the respective strap to the desired position. The tension of the individual belts can be varied and the desired support of the back can be set.
4. Place the back cushion back over the backrest starting at the front and ending at the back.
5. Secure the Velcro connections by pressing the cushion against the backrest with your hand.
6. Make sure that all straps are secured with Velcro.

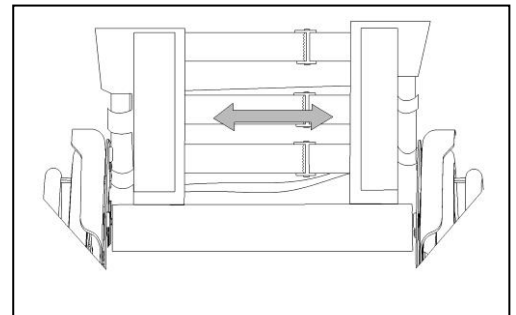

3.7.2 Backrest height (step adjustment)

1. Remove the back cushion.
2. Push the spring button located on the back of the back frame tube.
3. Move the backrest up/down to the desired height.
4. Make sure that the spring button clicks back in the corresponding hole.
5. Repeat for the other side. Make sure that both sides are set to the same height and that they are firmly secured.

3.7.3 Push handle height (stepless adjustment)

Fixing lever

1. Turn the push handle lever (40) to loosen it.
2. Move the push handle up/down to the desired height.
3. Secure the handle by tightening the lever (40).
4. Repeat for the second push handle. Make sure that both handles are set to the same height and that they are firmly secured.



Fixing knob

1. Turn the push handle knob (30) a few turns anticlockwise.
2. Move the backrest up/down to the desired height by pulling the handles.
3. Secure the backrest by tightening the knob; turn it clockwise.
4. Repeat for the other side. Make sure that both sides are set to the same height and that they are firmly secured.



3.8 Moving to/from wheelchair



Risk of injuries and damage

- In case you cannot perform the transfer in a safe manner, ask someone to assist you.
- Do not stand on the footplate during transfer into or out of the wheelchair.

Transfer

1. Position the wheelchair as close as possible to you when sitting in your chair, couch, seat or bed.
2. Apply both parking brakes to block the movement, see §3.1.
3. Turn the footrests to the side, or fold the footplates up to prevent standing on them.
4. Transfer to/from the wheelchair using the strength of your arms or with the help of attendant(s) or lifting equipment.

Sitting in the wheelchair

1. Sit down on the seat with your lower back against the backrest.
2. Turn the footrests to the front until they click into place, or fold down the footplates and put your feet on them.

3.9 Riding

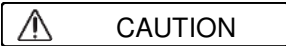

Risk of injuries and damage

- Before every usage, make sure that:
 - parking brakes are working properly.
 - tires are in good condition, see §4.
- Prevent your fingers from being caught by the wheel spokes.
- Do not operate the hand rims with wet hands.
- Prevent entrapment of your hands on the hand rims when you pass small passages.
- Do NOT drive on slopes, obstacles, steps or kerbs larger than specified in §5.
- When you stop on a (small) slope, use your brakes.
- Make sure all four wheels touch the ground while riding up or down a slope.
- Take slopes as slow as possible.
- Always stay on the pavement when riding on public roads.
- Pay attention if the road has holes or gaps that may cause entrapment of the wheels.
- Avoid stones and other objects that may block the wheels.
- Make sure that the footplates do not touch ground while taking an obstacle.
- Do not use your wheelchair on an escalator.
- If available, wear your safety belt.
- Always keep the swing range of the footplate in mind to prevent bystanders from being injured or objects from being damaged.
- If you don't have enough experience riding your wheelchair, ask assistance of an attendant. Keep your arms away from the wheels and keep your feet on the footplate.
- Stairs should always be negotiated with the help of two attendants.
- Never try to use stairs that are not appropriate for wheelchairs.

3.9.1 Riding your wheelchair:

1. Release the brakes.
2. Take both hand rims at their highest position.
3. Lean forward and push the hand rims forward until your arms are straight.
4. Move your hands back to the top of the hand rims and repeat the movement.

4 Maintenance

4.1 Points of maintenance



Risk of injuries and damage

Repairs and replacements may only be undertaken by trained persons and only genuine replacement parts of Vermeiren should be used.

i The service frequency depends on the frequency and intensity of use. Contact your dealer to agree to a common timetable for inspection/maintenance/repair.

For the maintenance manual, refer to the Vermeiren website: www.vermeiren.com.

Before each use

Inspect the following points:

- All parts: Present and undamaged or unworn.
- All parts: Clean, see § 4.2.2.
- Wheels, backrest, seat, calf rests, arm rests, footplates: Well secured.
- Condition of wheels/tyres, see § 4.2.1;
- Condition of frame parts: No deformation, instability, weakness or loose connections
- Seat, backrest, arm pads, calf pads and head rest (if applied): No excessive wear (like dented spots, damage or tears).
- Brakes: Undamaged and functioning.

Contact your specialist dealer for possible repairs or part replacements.

Yearly or more often

Have your wheelchair inspected and serviced by your specialist dealer, at least once a year, or more often. The minimum maintenance frequency depends on use and should therefore be commonly agreed on with your specialist dealer.

4.2 Maintenance instructions

4.2.1 Wheels and tyres

i Proper working of the brakes depends on the state of the tyres, and can change due to wear and contamination (water, oil, mud, ...).

Keep your wheels free of wires, hair, sand and fibres.

Check the profile of the tyres. If the tread depth is less than 1 mm, the tyres need to be replaced.

Contact your specialist dealer for this matter.

Inflate each pneumatic tyre to the correct pressure (see pressure indication on the tyres).

4.2.2 Cleaning



Risk of damage by moisture

- Never use a hose or high-pressure cleaner to clean the wheelchair.

Wipe all rigid parts of the wheelchair with a damp cloth (not drenched).

If necessary, use a mild soap, suitable for varnishes and synthetics.

The upholstery can be cleaned with lukewarm water and a mild soap. Do not use abrasive cleaning agents to clean.

4.2.3 Disinfection

CAUTION

Risk of damage

- Disinfections may only be undertaken by trained persons. Consult your specialist dealer.

4.3 Troubleshooting

Even if you use your wheelchair properly, a technical problem may occur. In this case, contact your local specialist dealer.



WARNING

Risk of injuries and damage to the wheelchair

- NEVER repair your wheelchair yourself attempting to solve the problem.

The following symptoms may indicate a serious problem. Therefore always contact your specialist dealer if you spot any of the following deviations:

- Strange sound;
- Uneven tread wear on one of the tyres;
- Jerky movements;
- Wheelchair deflects to one side;
- Damaged or broken wheel assemblies.

4.4 Expected lifespan

The average lifespan of your wheelchair is 5 years. Depending on the frequency of use, driving circumstances and maintenance, the lifespan of your wheelchair will increase or decrease.

4.5 Reuse

Before reuse by another person, have the wheelchair disinfected, inspected and serviced according to the instructions in §4.1 and §4.2.

4.6 End of use

At end of life, you need to dispose your wheelchair according to the local environmental legislation. The best way to do so, is to disassemble the wheelchair to facilitate the transport of recyclable parts.

5 Technical specifications

The technical details below are only valid for this wheelchair, at standard settings and optimal ambient conditions. Take these details into account during use.

The values are no longer applicable if your wheelchair has been modified, damaged or suffers from severe wear.

Table 1: Technical specifications

Brand	VERMEIREN	
Type	Wheelchair	
Model	Trigo T	
Description	Specifications	
Max. weight of user	For seat width up to 360 mm with single cross: 70 kg For seat width from 380 up to 460 with 1.5 cross: 130 kg For seat width from 480 up to 500 with double cross: 130 kg	
Static stability	5°	
Dimensions	Min.	Max.
Overall length	676 mm	1046 mm
Dismantled length (wheels dismantled)	650 mm	855 mm
Dismantled width (wheels dismantled)	386 mm	586 mm
Folded height (depending on wheel diameters)	457 mm	660 mm
Wheelchair height (depends on type of rear wheel, adjustment, push handle or backrest height)	457 mm	945 mm
Folded height without wheels	Max. 428 mm	
Seat width	300 mm	500 mm
Overall width in mm (24" rear wheels, 0° camber):	460 mm	660 mm
Wheelchair length (depending on seat-depth, type of rear wheel, type of footplate, adjustment)	676 mm	1046 mm
Canvas depth – Sit depth	320 mm	500 mm
Backrest height, adjustable	(in steps of 25 mm)	
Non-foldable BR	250 - 300	
Non-foldable BR	300 - 350	
Foldable BR	350 - 400	
Foldable BR	400 - 450	
Foldable BR	450 - 500	
Backrest height, fixed, foldable	250 – 510 mm (in steps of 20 mm)	
Seat height at front seat-edge of seat, in relation to front wheels	(in steps of 10 mm)	
3" front wheel	380 - 470	
4" front wheel	390 - 490	
5" front wheel	410 - 500	
6" front wheel	430 - 510	

Seat height at rear seat-edge, depending on rear wheel	(in steps of 10 mm)
18" rear wheel	315 – 415
20" rear wheel	335 - 435
22" rear wheel	355 – 465
24" rear wheel	385 – 495
26" rear wheel	405 - 515
Distance between side plate/mudguard and seat	0 mm
Distance between footplate and seat	240 – 460 mm
Footrest length, adjustable	240 – 460 mm
Seat plane angle adjustable	20°
Angle between seat and footrest	Fixed, 70°, 80° or 90°
Angle foot plate and footrest	20° (in steps of 5°)
Weights	
Total mass	Starting from 10 kg
Mass of heaviest part (without seat and back cushion, wheels)	7.2 kg
Masses of removable parts:	
Wheel 24"	3.1 kg
Backrest cushion	0.4 kg
Seat cushion	0.4 kg
Footrest with footplate	0.65 kg
Push handle (adjustable)	0.4 kg
Wheels	
Camber angle of rear wheels default setting, adjustable	0° 2° 4° 6°
Front wheels	3" - 4" - 5" - 6"
Rear wheels	18" - 20" - 22" - 24" - 26"
Hand rim diameter	400 mm – 440 mm – 500 mm – 535 mm – 600 mm
Tyre pressure, rear wheels	2.5 - 10 bar
Environment	
Strength tests according to	ISO 7176-8
Ignitability of upholstery according to	EN 1021-2
Overall rating of belt-restraint accommodation	C
Storage and use temperature	+5 °C ~ +41 °C
Storage and use humidity	30% ~ 70%
We reserve the right to introduce technical changes. Measurement tolerance ± 15 mm /1,5 kg / 1,5°.	

**Service registration form**

This product (name):

was inspected (I), serviced (S), repaired (R) or disinfected (D):

By (stamp): Kind of work: I / S / R / D Date:	By (stamp): Kind of work: I / S / R / D Date:	By (stamp): Kind of work: I / S / R / D Date:
By (stamp): Kind of work: I / S / R / D Date:	By (stamp): Kind of work: I / S / R / D Date:	By (stamp): Kind of work: I / S / R / D Date:
By (stamp): Kind of work: I / S / R / D Date:	By (stamp): Kind of work: I / S / R / D Date:	By (stamp): Kind of work: I / S / R / D Date:
By (stamp): Kind of work: I / S / R / D Date:	By (stamp): Kind of work: I / S / R / D Date:	By (stamp): Kind of work: I / S / R / D Date:
By (stamp): Kind of work: I / S / R / D Date:	By (stamp): Kind of work: I / S / R / D Date:	By (stamp): Kind of work: I / S / R / D Date:



Vermeiren GROUP
Vermeirenplein 1 / 15
2920 Kalmthout
BE

website: www.vermeiren.com

Instructions for specialist dealer

This instruction manual is part and parcel of the product and must accompany every product sold.

Version: E, 2022-09

Basic UDI: 5415174 122106Trigo T TX

All rights reserved, including translation.